

1T9927EL | FORTYEIGHT Label 4 - Suspension

Professional low voltage LED fixture for direct lighting

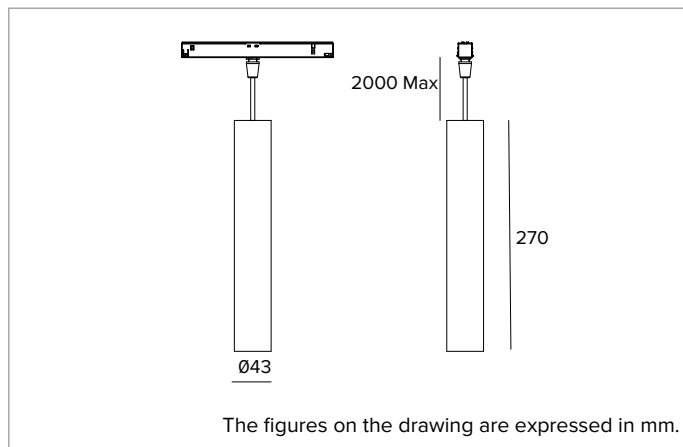

	2700K	H(m)	D(m)	Emax(lx)
	Ra90		18°	
Fixture Power	8W	1	0.31	3613
Source Flux	842lm	2	0.62	903
Fixture Flux	533lm	3	0.93	401
Efficacy	71lm/W	4	1.24	226
TS1966	I _{max} =4291cd/klm	I _{max}	3613cd	5
			1.55	145



SOURCE

High efficiency Chip on Board LED Ra90. 3500K on request.

Energy efficiency class: F

Nominal power: 6,9W

Nominal flux: 842lm

Colour rendering index: 90

Rf: 92

Rg: 99

CCT nominal: 2700K

SDCM: 1.5

Lifetime (L80/B10): >50000h tq +25°C

ILLUMINOTECHNICAL CHARACTERISTICS

SP Version - metallised polycarbonate precision optics, a holographic diffusion filter and a black silicone cut off ring.

Optic: REFLECTOR

Beam angles: SP

Optical efficiency: 63%

Fixture flux: 533lm

Luminous efficacy: 71lm/W

Photobiological safety: Compliant with RG1 low risk group

MECHANICAL CHARACTERISTICS

Cylindrical body in CNC machined aluminum and coated with powder paint.

Colour and finish: Deep black

Dimensions: D=43mm

Weight: 0.4Kg

Version: ON-OFF

Degree of protection: IP20

ELECTRICAL CHARACTERISTICS

ON-OFF version, track power supply.

Fixture Power: 8W

Power supply: 48Vdc

Insulation Class: CLASS 3

Class F: YES

SAFE FLICKER: PstLM=<1 and SVM=<0.4 (IEC TR 61547-1 and IEC TR 63158), to ensure a more comfortable and safe light

Ambient temperature: 0°C / +25°C

INSTALLATION

Complete with 2000mm long multicore suspension cable in coloured fabric with length adjustment system. Black feeding cable. Quick coupling system for mounting the product on the track.

NOTES

Not polarized fixture. Black adapter. 110-277Vac version available on request.

WARRANTY

5 years.

WARNING

Luminaire designed for disposal/recycling at end-of-life. Replaceable (LED only) light source by a professional. Replaceable control gear by a professional.

Due to the technological evolution of the electronic components, the data provided may be updated, and as such, confirmation must be requested during the order process.

Luminous flux and power supply have +/-10% tolerances with respect to the indicated value. tq +25°C (CIE 121).

We reserve the right to make technical changes.

Targetti Sankey S.r.l.
Via Pratese, 164
50145 Firenze - Italy
Tel: +39 055 37911
targetti.com
targetti@targetti.com

CCIAA Firenze
Share Capital:
€ 500.000,00
VAT N. (IT):
01537660480
R.E.A: FI-275656

TARGETTI